

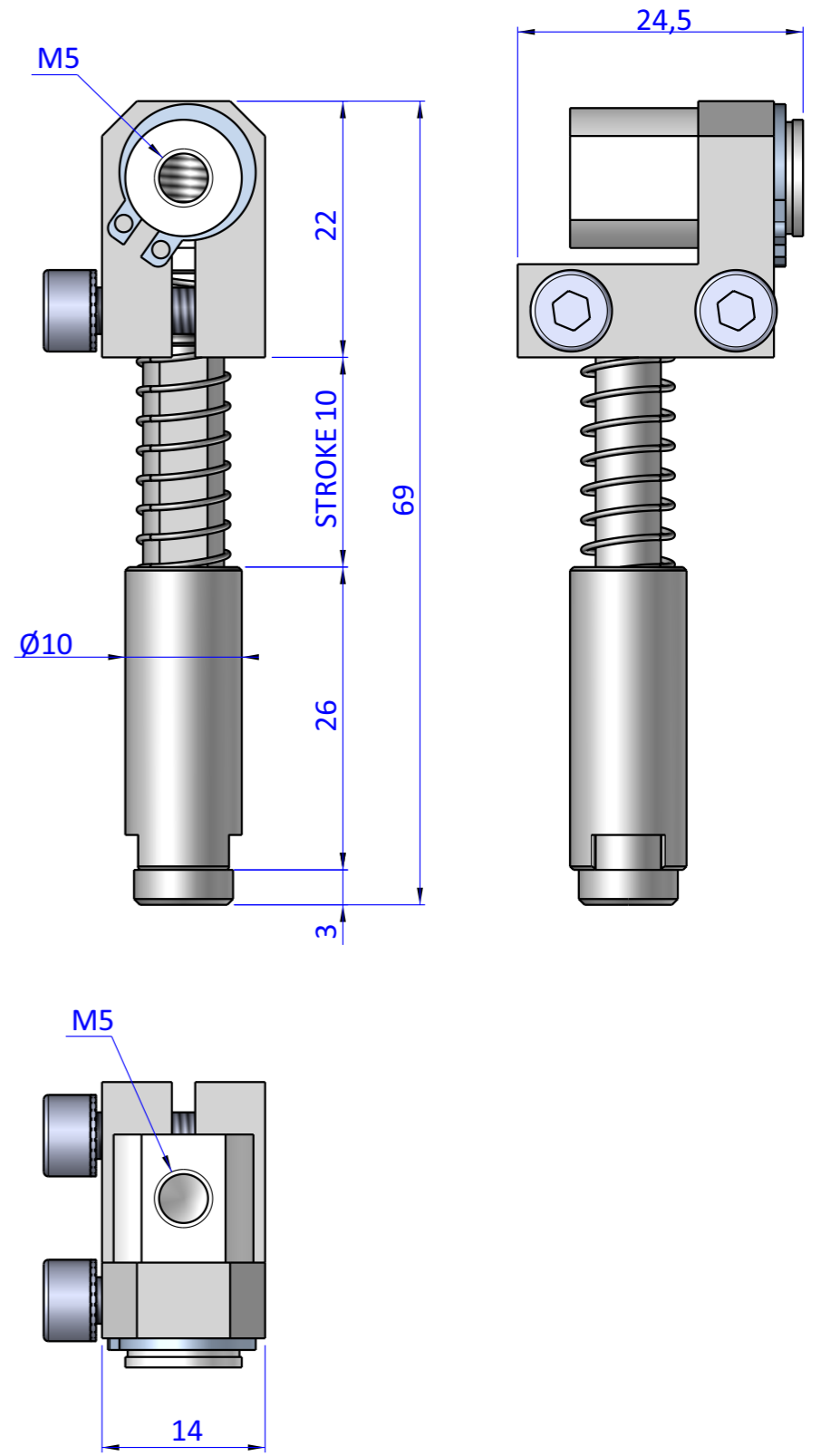

THE PROPERTY OF THE DRAWING IS ESTABLISHED BY LAW. IT IS FORBIDDEN TO PRODUCE OR SHOW IT TO THIRD PART. WITHOUT A WRITTEN AGREEMENT.

Item	Name	Q.ty
1	05.01.005.07	1
2	05.01.005.08	1
3	A.ELA10	1
4	GG.S.01.01	1
5	GG.S.02.01	1
6	M.8x26	1
7	R.4.SCH	2
8	V.TCE4x14	2

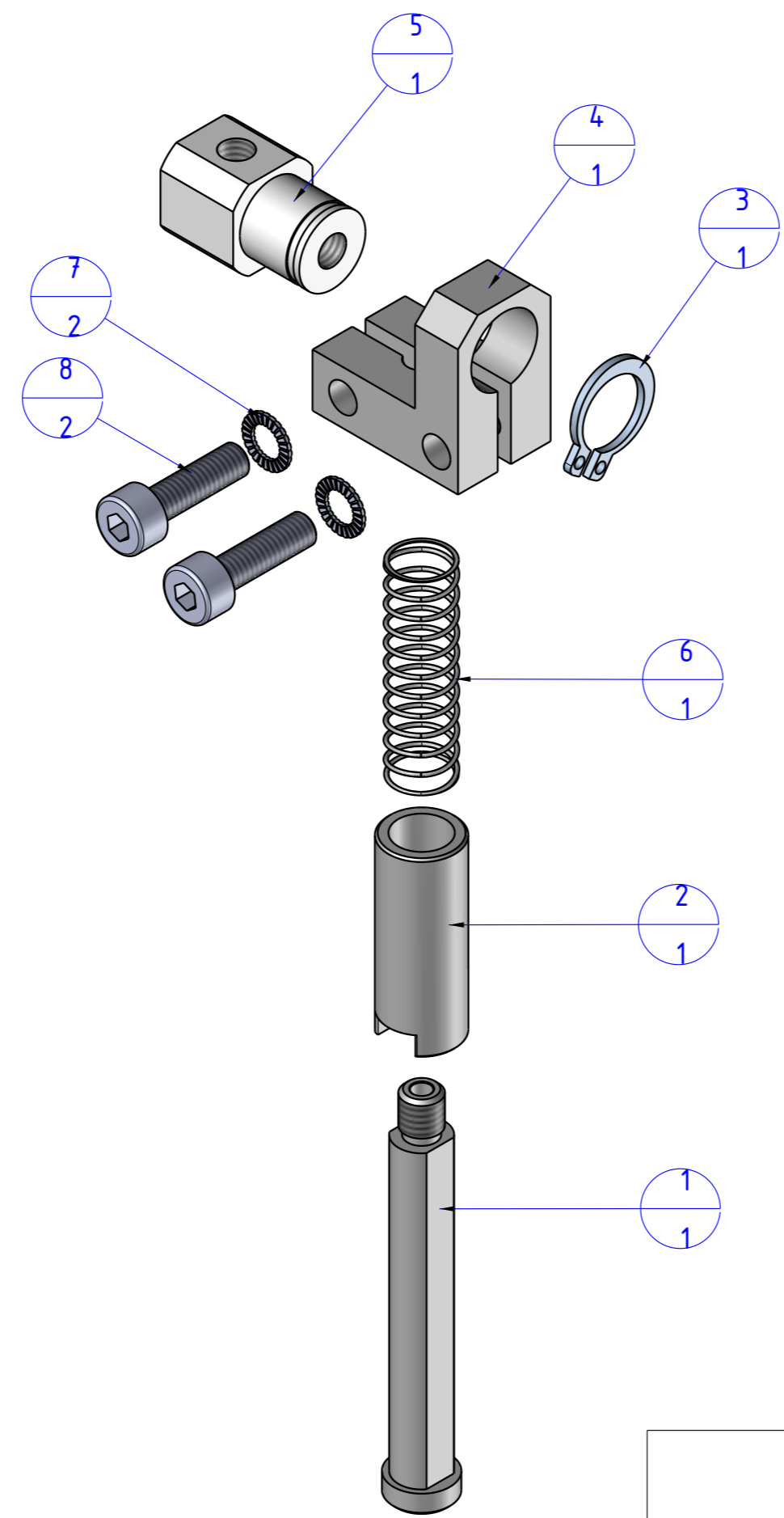

Format A3
UNI 936-76

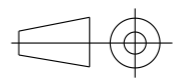
 FPS FPSERVICES AUTOMATION			DESIGNED FROM FPS Automation	REVIEW A
GENERAL TOLERANCE UNI - ISO 2768 CLASSE f	DESCRIPTION CA.GGS100515	DATE 09/09/2020	WEIGHT 0,037kg	CODE CA.GGS100515